

HIGHLIGHT TECH CORP.



HIGHLIGHT TECH CORP.
70968 台南市安南區工明南二路106號
TEL:+886-6-2460-296 | FAX:+886-6-2478-022



CONTENTS

	About High-Light Technology Group	P.1
	Vacuum Service	P.3
	• Turbo Molecular Pump/Dry Vacuum Pump overhaul and service	
	• New/used vacuum pump trading •Valve overhaul and repair	
	Vacuum System	P.5
	• Vacuum parts • Customized vacuum chamber	
	• Customized vacuum system design/manufacturing	
	Environment Engineering	P.6
	• Semiconductor equipment power supply and system •System optimization	
	• Service •Htc own system	
	Power Supply/Plasma Generator	P.7
	• Semiconductor equipment power supply and system • System optimization	
	• Service •Htc own system	
	Cleaning Engineering	P.8
	• Target/Semiconductor parts clean • Spare parts management	
	• Rare metals/materials recycle	
	Service Location	P.9



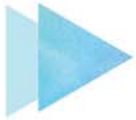

About Htc

Vacuum Expert/Integrated Vacuum System, Pump Service, Generator and tail gas Solution

Htc is established in 1997, specialize on excellent vacuum technology which can be applied for living technology, 3C products, semiconductor industry, optoelectronic industry, touch panel and photovoltaics and etc. With its professional and unique system integration capability, system design knowhow and vacuum pump knowledge, Htc is the best business partner for vacuum system, vacuum equipment, vacuum pump and thin film deposition providers.

- Vacuum Service
- Vacuum System
- Environment Engineering
- Power Supply/Plasma Generator
- Cleaning Engineering

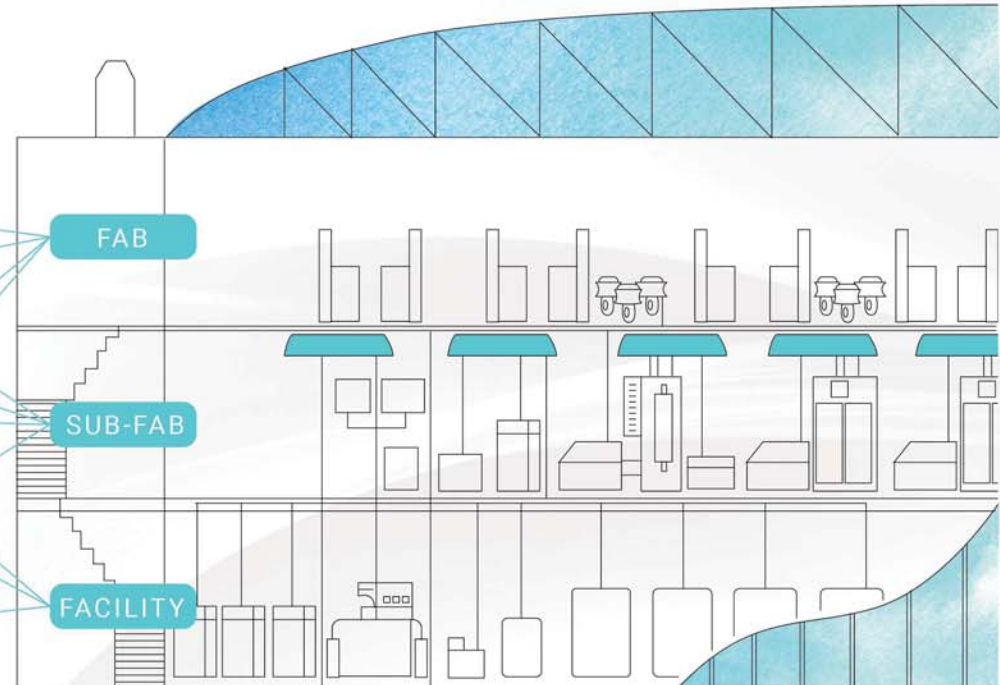



Vacuum Service



Htc provides highest quality and reliability for different customer according to their individual demands

Biggest TMP overhaul provider globally

Over 2.4k pcs a year

More than 280 pcs per month

Outstanding key parts development

Stator \ rotor blade \ magnetic bearing \ dry screw \ roots claw \ controller

Advanced processing experience

The only TMP service company with advanced 7nm node process experience

24-7 service

The first 24-7 service provider

High class cleaning and assembly



Service Brand



Taiwan TMP Exclusive

Vacuum Pump Service Brand

Kashiyama 楷山工業

Shimadzu 島津製作所

Ebara 荏原製作所

ULVAC アルバック

Taiko 大晃機械

Pfeiffer 浦發真空

Alcatel Adixen阿爾卡特

Leybold 萊寶

OERLIKON 歐瑞康

Vacuum Valve Service Brand

VAT 偉拓科技

SMC速睦喜

CKD 中京電機株式會社

V-TEX 株式會社ブイテックス 韋特庫斯

MKS 萬機科技

HVA

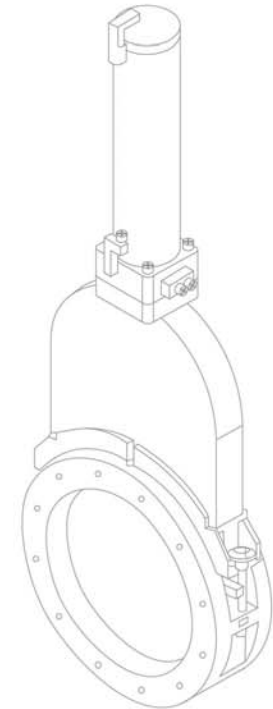

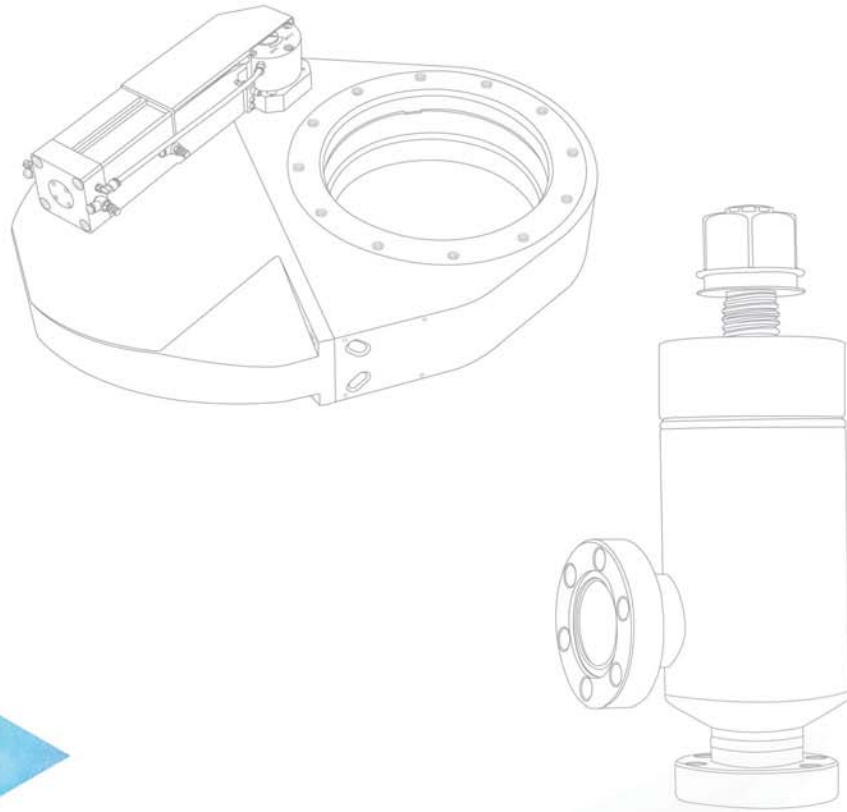

3M Fluorinert

Vacuum Service

From decades experience of vacuum system, Htc provide customer with the highest quality of vacuum parts from valve to flange, clamp to pipe

Besides vacuum parts, Htc also provide our customer the whole vacuum system design. From chamber, vacuum piping, automation, valve, pumping system to tail gas abatement, Htc are capable to fulfil all demands from customer and is always the best choice for our customers

Tight connection and collaboration with global vacuum system provider is also a key strategy of Htc. Htc's vacuum parts have been certified by many global pier-one system suppliers. Together with highest quality and high degree customization, Htc is already the global leading vacuum supplier.

Environment Engineering

With more and more environment regulation and corporate responsibility, there must be more efficiency to abate waste. Htc provide the highest grade of processing waste gas from semiconductor industry. Our wet scrubber can reach PM2.5 abatement rate more than 95%.

Our wet scrubbers have been widely used by semiconductor/optoelectronics industries all over Japan, Taiwan and China.



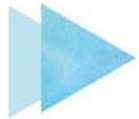
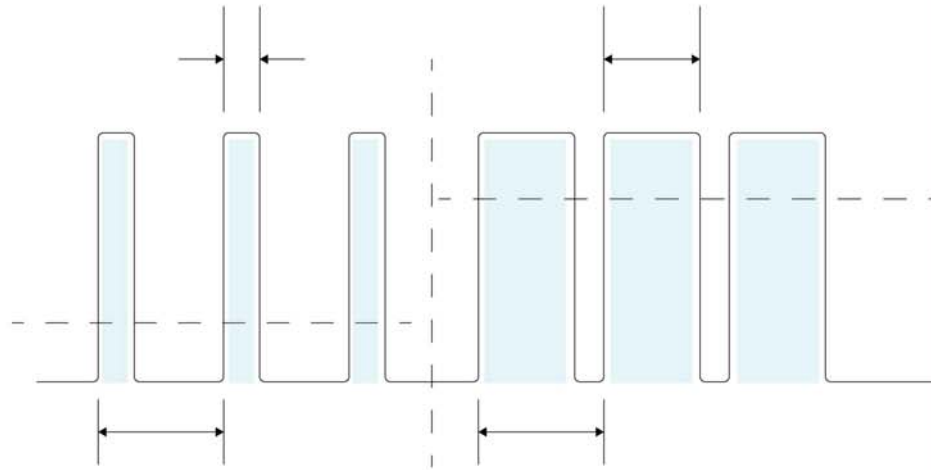

Power Supply/Plasma Generator

• Plasma Physics and Technology • High Power RF and Microwave Technology • High Voltage and High Power Technology • Electronic Circuit/Single Chip Control Technology

Advanced process must be achieved by very precise power and signal supply, Htc has a lot of valuable experience on RF/microwave/DC pulse power supply, ozone sensor and generator, CMP motor, ETO system and RPS. With this valuable experience, Htc can provide our customer highest quality and reliability.

Apart from overhaul and repair service, Htc's professional experts can consult our customer optimize their ETO system and RPS. Htc also developed our own products with many years optimization experience, there are so far : RPS performance monitor and microwave power system monitor

Service Brand— Kyosan 京三 / AE 艾儀 / MKS 萬機科技 / Trumpf 霍廷格



Cleaning Engineering

Keen to develop best gold stripping and cleaning technology to help our customer achieve highest utilization rate

Rare metal recycle, semiconductor parts cleaning, optoelectronic parts cleaning, photovoltaics parts cleaning, thermal spray and coating. Htc provide high reliability, accurate delivery and long term business to establish mutual trust with customers. In order to serve customer locally, Htc set service center in Hukou and Tainan to meet customer's expansion and production.

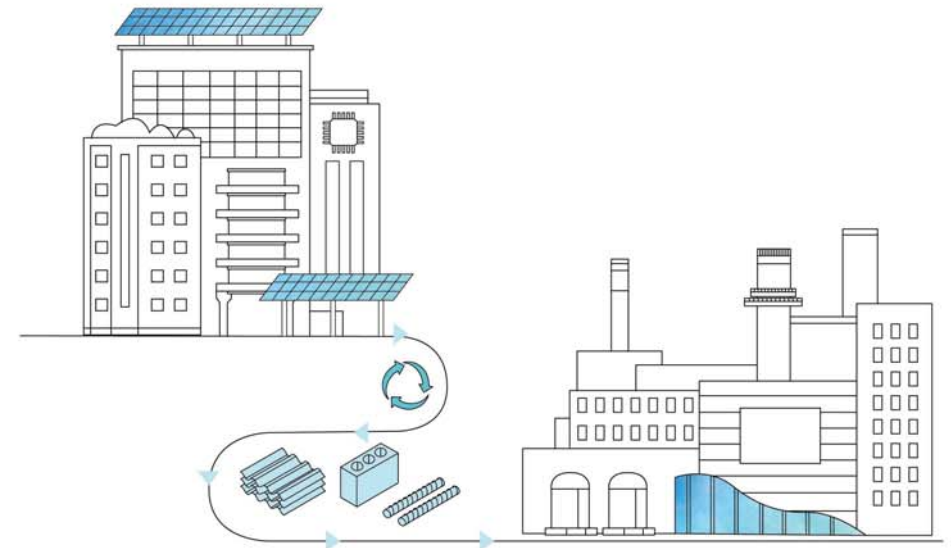

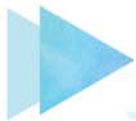

Service Spots



Official Website

-  Major Customers
-  Agents
-  Htc Vacuum

Tainan Headquarter

Address : No. 106,Gung-Min South Road II An-Nan District, Tainan City,Taiwan 70968
 Tel : +886-6-2460296
 Fax : +886-6-2478022
 Website : www.high-light.com.tw
 Mail : ec@high-light.com.tw



Map

Tainan Center

Address : No. 101,Gung-Min South Road I An-Nan District, Tainan City,Taiwan 70968
 Tel : +886-6-5116111
 Fax : +886-6-2564001 / +886-6-5105168



Map

Hsinchu Center

Address : No.32., Guangfu Rd., Hukou Township, Hsinchu County 303, Taiwan
 Tel : +886-3-5973325
 Fax : +886-3-5973330 / +886-3-5973326 / +886-3-5973083



Map

Taichung Service Center

Address : No. 958, Zhongke Rd., Daya Dist., Taichung City 428, Taiwan 42881
 Tel : +886-04-25606357



Map

Shanghai Headquarter

Address : No. 51,Cheng Yin Rd,Baoshan City Industrial Zone,
 Shanghai 200444, China
 Tel : +86-21-36162036
 Fax : +86-21-36162037
 Website : www.high-light.com.cn
 Mail : htcvacuum@high-light.com.cn



Map